

# VISUAL INSPECTION OF CRIMPED TERMINALS INDUSTRIAL

## Open Barrel Terminals

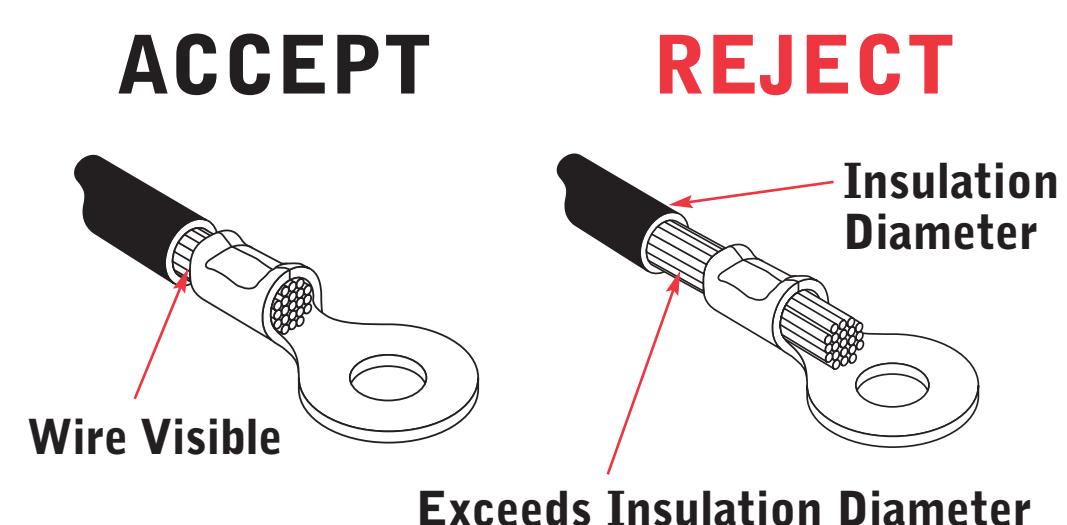

## Crimp Types

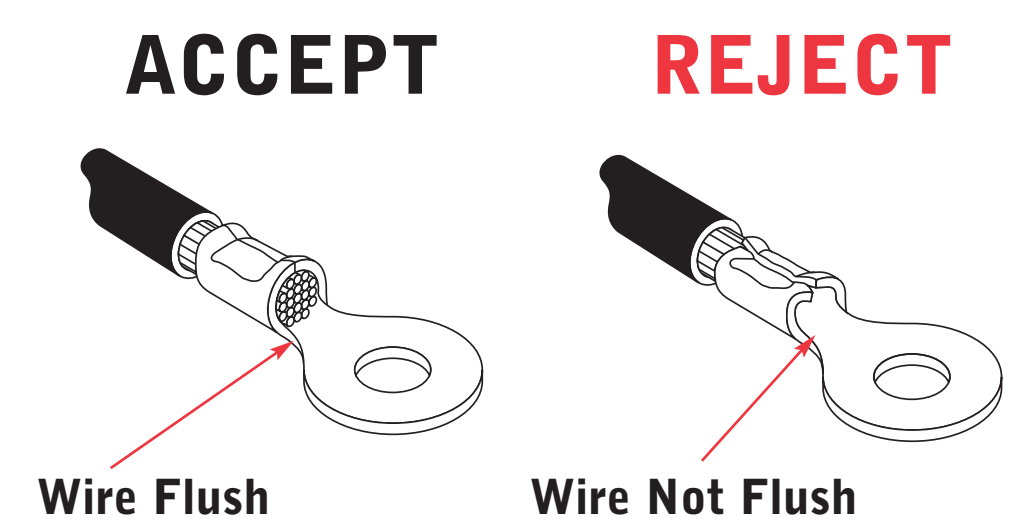
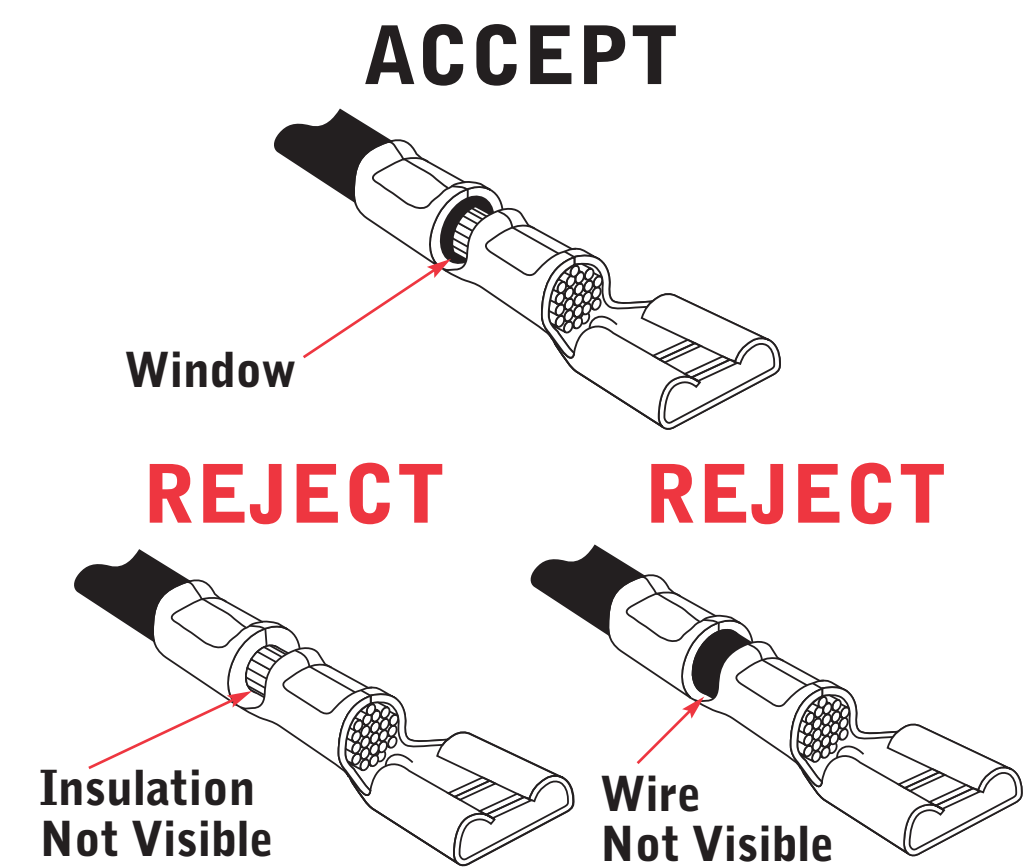
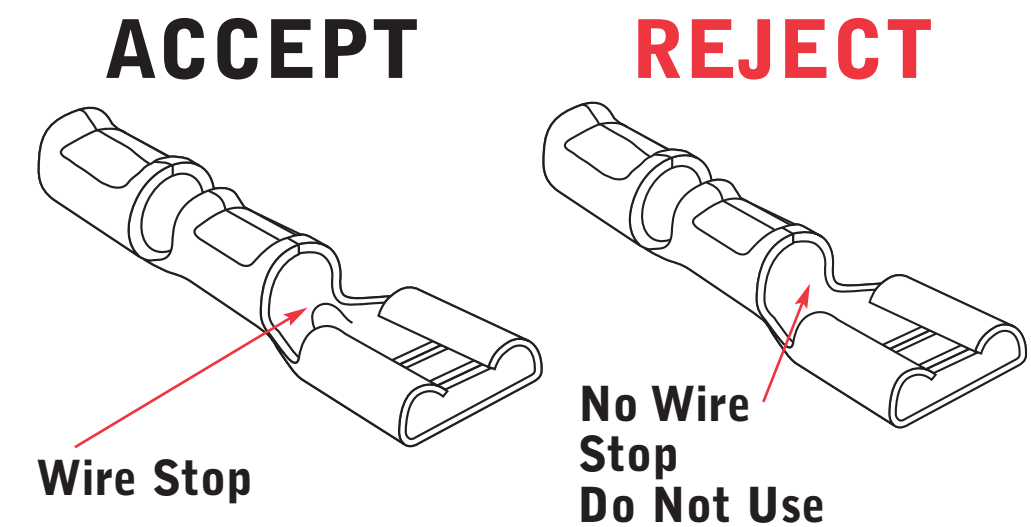
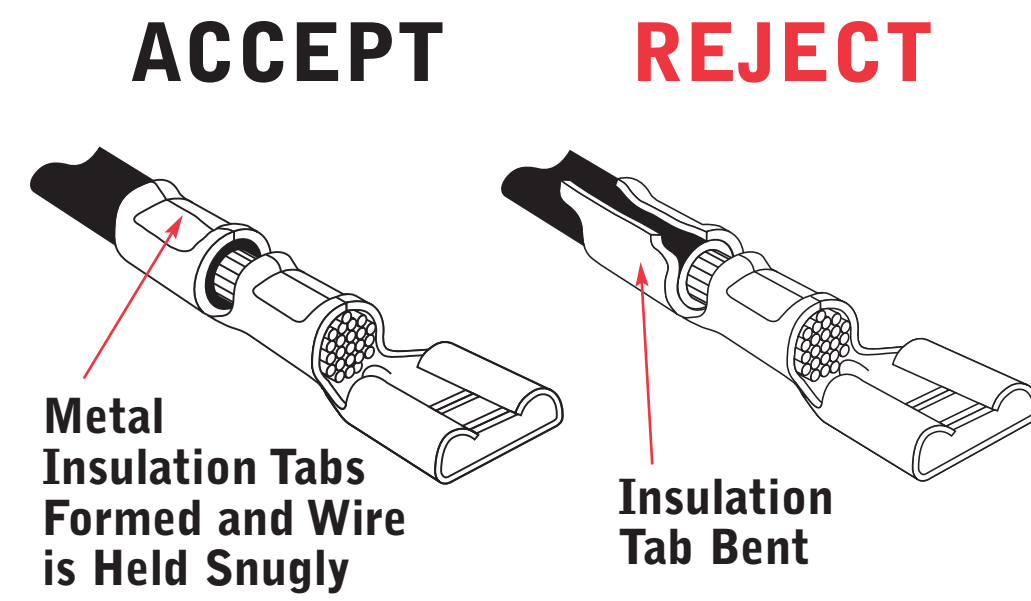
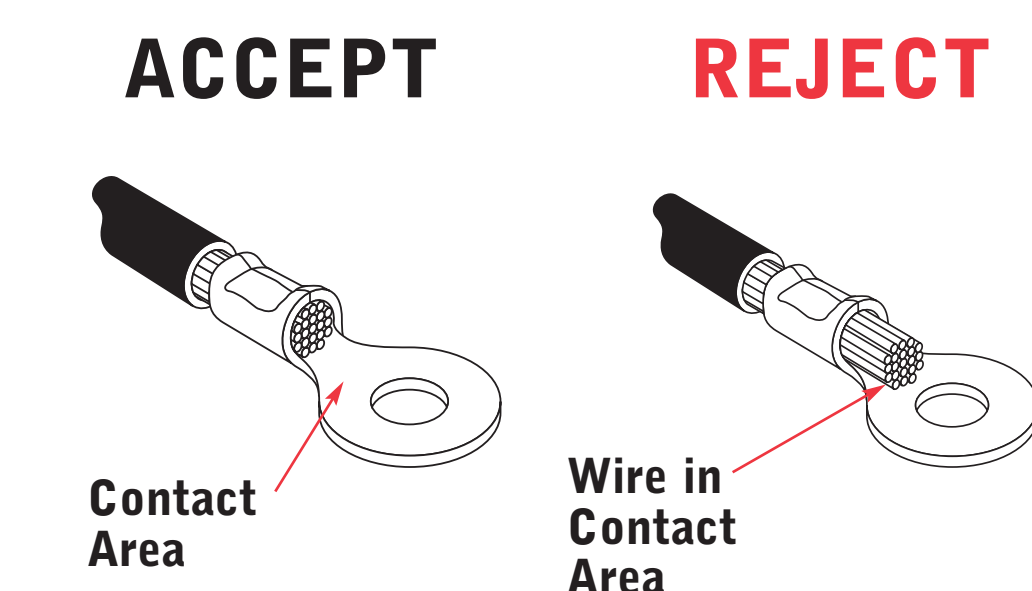
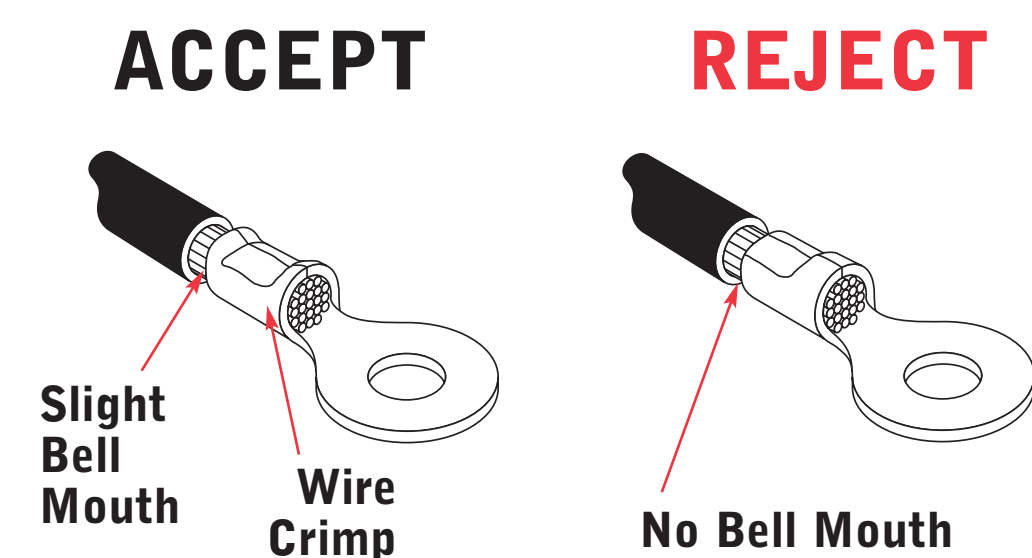
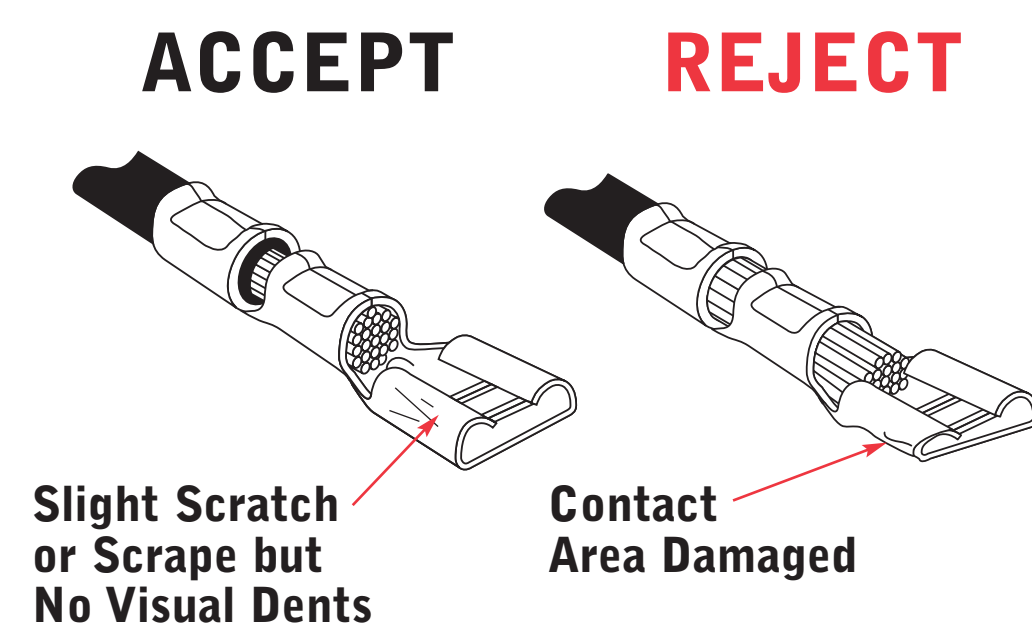
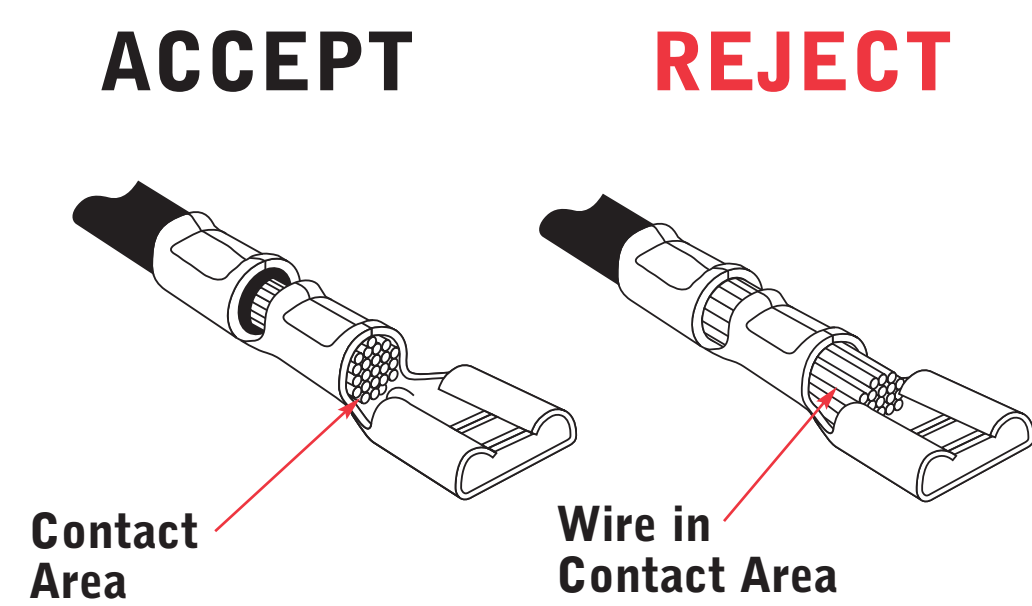
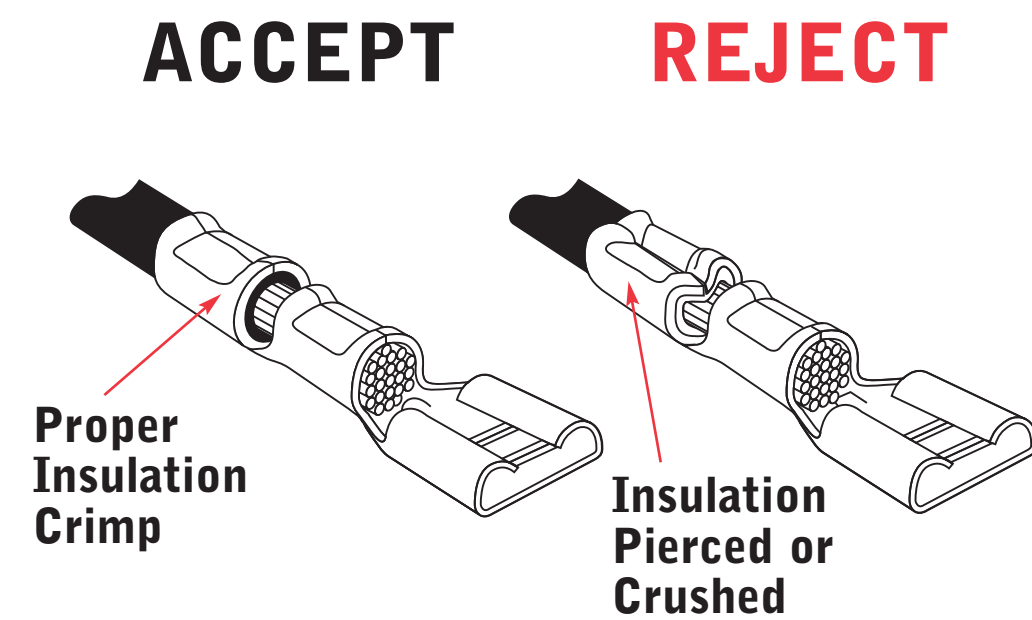
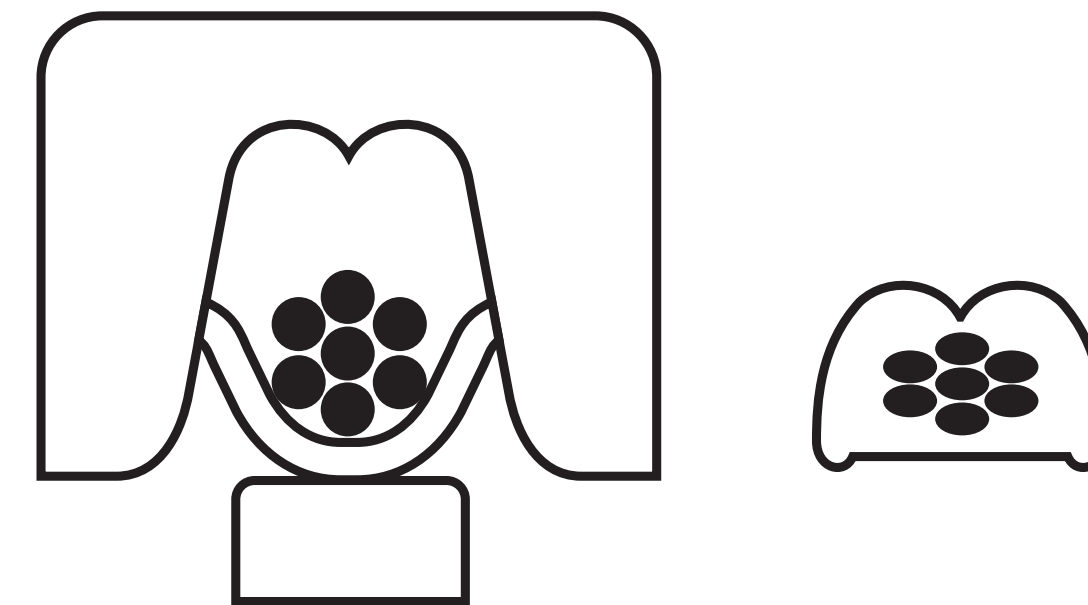

F CRIMP FOR OPEN BARREL TERMINALS

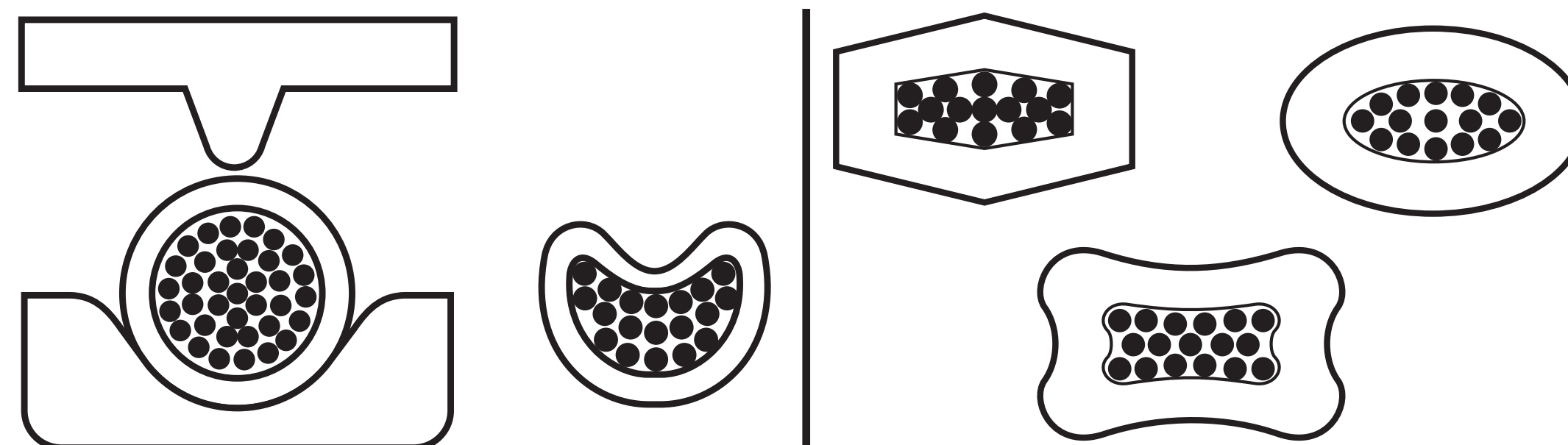

INDENTOR CRIMP FOR CLOSED BARREL TERMINALS

CONFINED CRIMP FOR CLOSED BARREL TERMINALS

Tensile Strength in Pounds

Wire Size	*UL-486A	*UL-486-C	*UL-310	*Military Class 2
26	3	N/A	N/A	7
24	5	N/A	N/A	10
22	8	8	8	15
20	13	10	13	19
18	20	10	20	38
16	30	15	30	50
14	50	25	50	70
12	70	35	70	110
10	80	40	80	150
8	90	45	N/A	225
6	100	50	N/A	300
4	140	N/A	N/A	400
2	180	N/A	N/A	550
1	200	N/A	N/A	650
1/0	250	N/A	N/A	700
2/0	300	N/A	N/A	750
3/0	350	N/A	N/A	825
4/0	450	N/A	N/A	875
250 MCM	500	N/A	N/A	1000
300 MCM	550	N/A	N/A	1120
350 MCM	600	N/A	N/A	1125

AWG-CMA Table

Terminal Size	CMA Range
26-22	202 - 810
24-20	320 - 1,020
22-18	509 - 2,600
22-16	509 - 3,260
16-14	2,050 - 5,180
14-12	3,260 - 8,213
12-10	5,180 - 13,100
8	13,100 - 20,800
6	20,800 - 33,100
4	33,100 - 52,600
2	52,600 - 83,700
1/0	83,700 - 119,500
2/0	119,500 - 150,500
3/0	150,500 - 190,000
4/0	190,000 - 231,000

### Technical Wire Information

**CMA** - Circular Mil Area is a unit of area equal to that of a circle whose diameter in one Mil.

**MIL** - One mil equals .001 inches.  
.001 = 1 mil  
.030 = 30 mils  
.125 = 125 mils

- \* **UL - 486 A** - Terminals (Copper conductors only)
- \* **UL - 486 C** - Butt Splices, Parallel Splices, Closed End Connectors and Wire Nuts
- \* **UL - 310** - Quick Disconnects, Flag and Couplers
- \* **Military Class 2** - Military Approved Terminals only as listed

## Closed Barrel Terminals

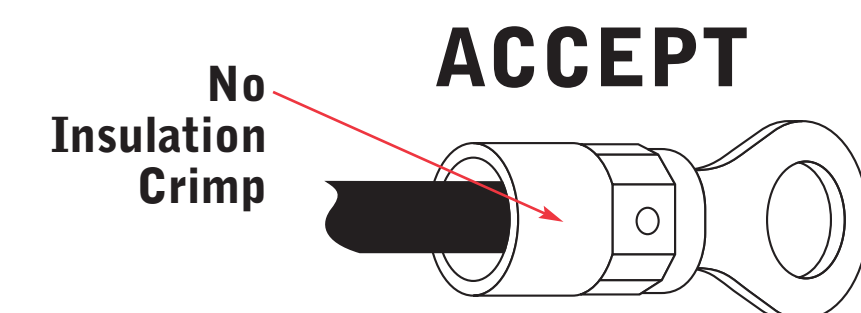
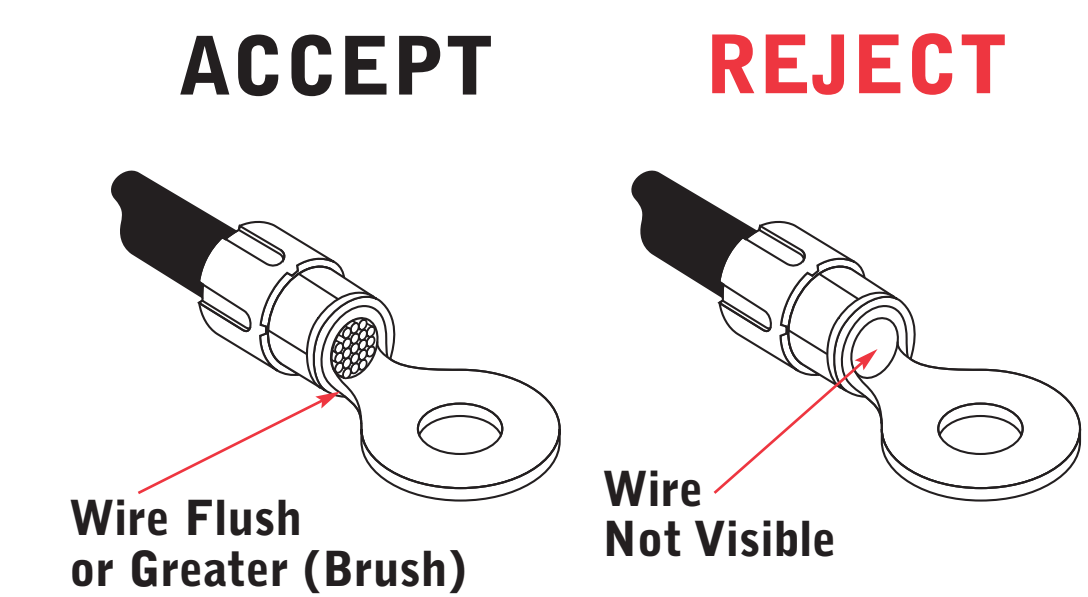
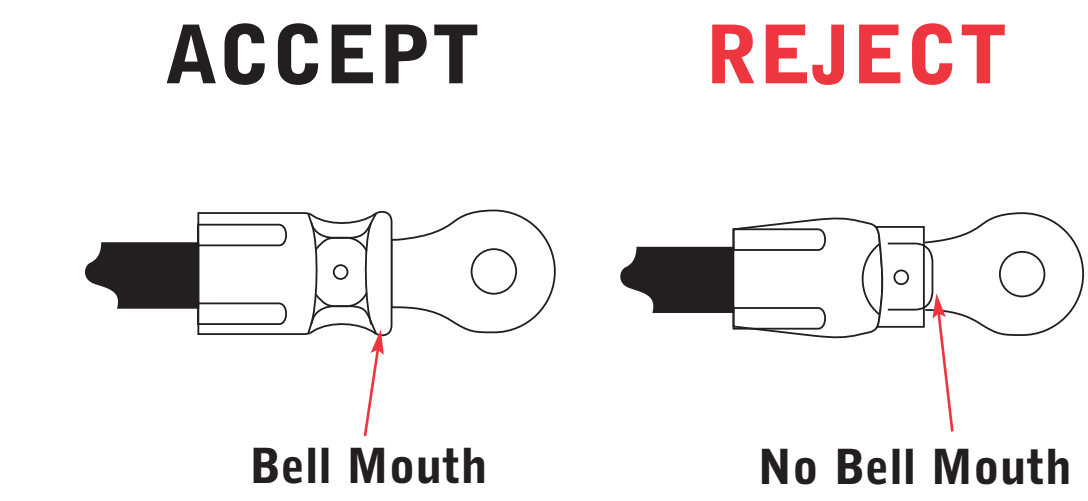

Wire Flush or Greater (Brush) Wire Not Visible  
Wire sizes of 8 AWG and larger do not require an insulation crimp.  
Wire sizes of 18 through 10 AWG require an insulation crimp and the wire can be held securely in the insulation crimp.

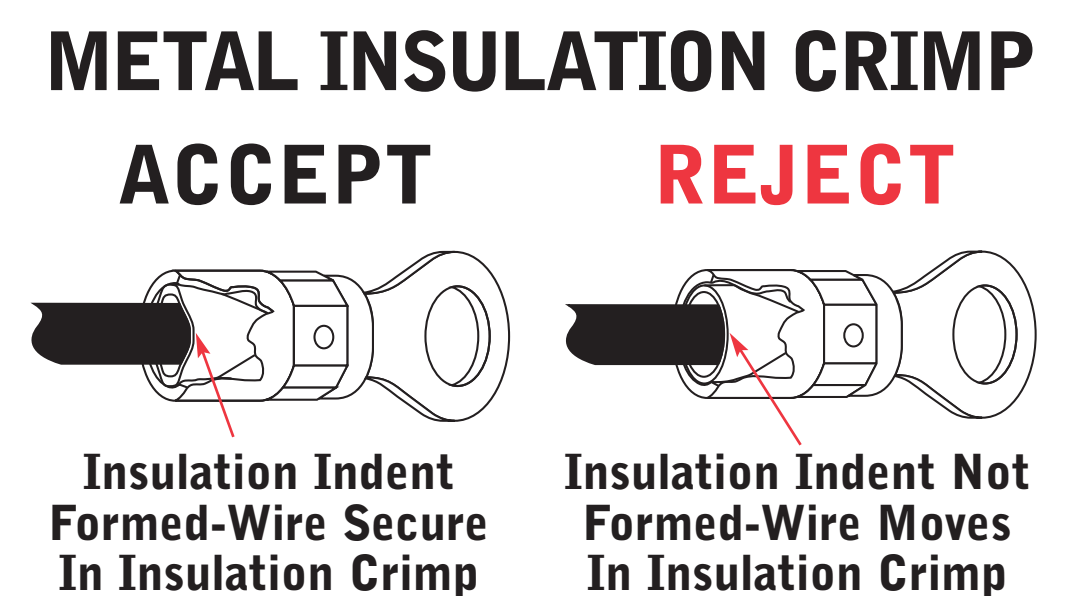
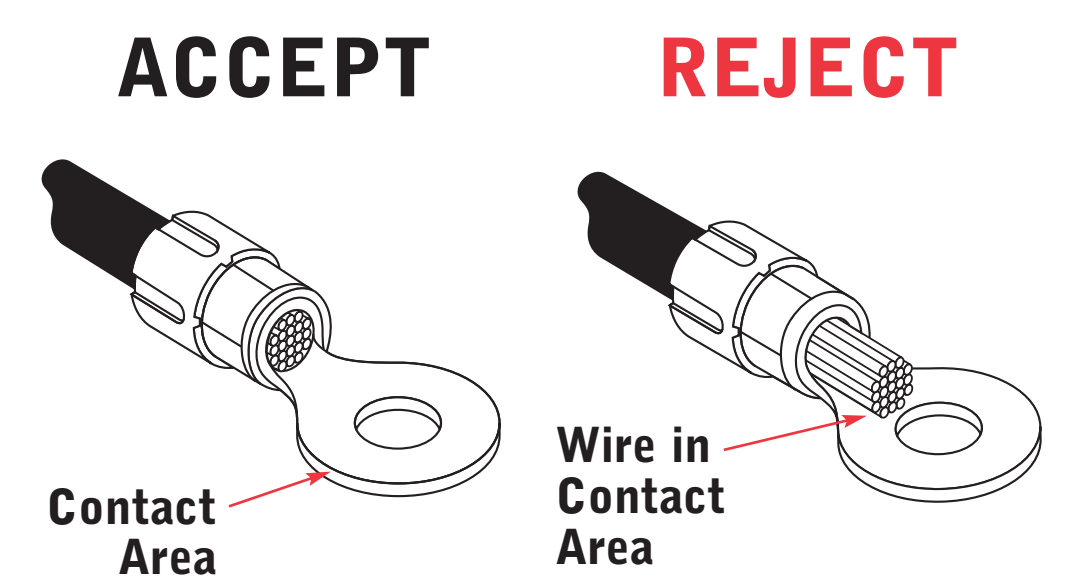
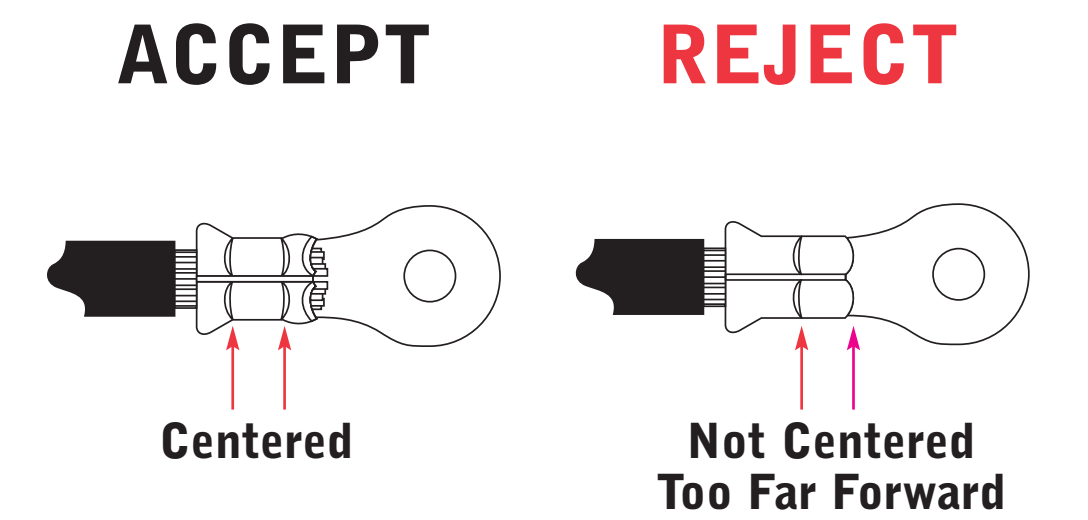

### BUTT SPLICES 10 to 18 AWG

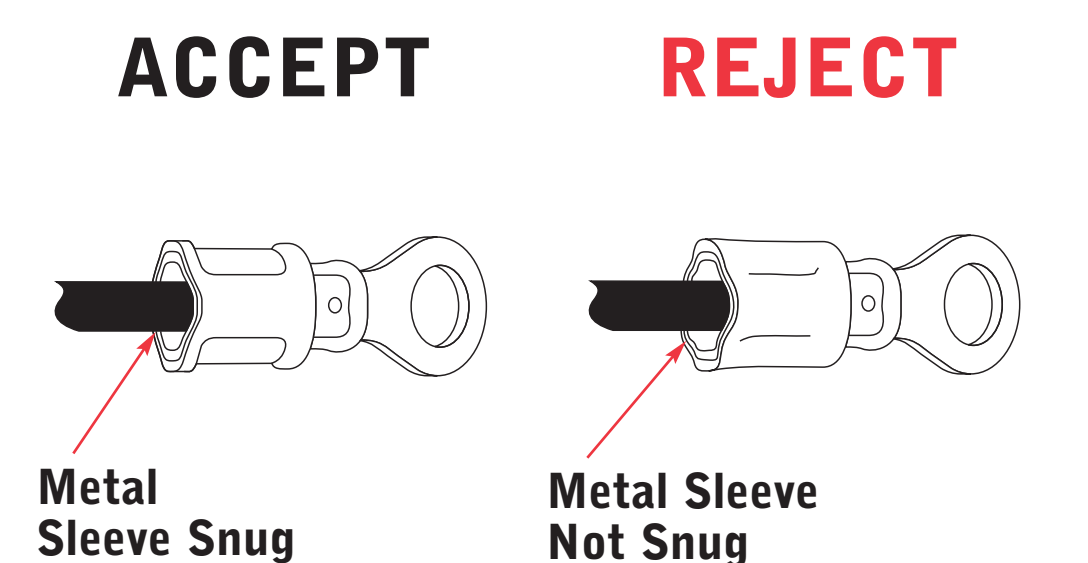
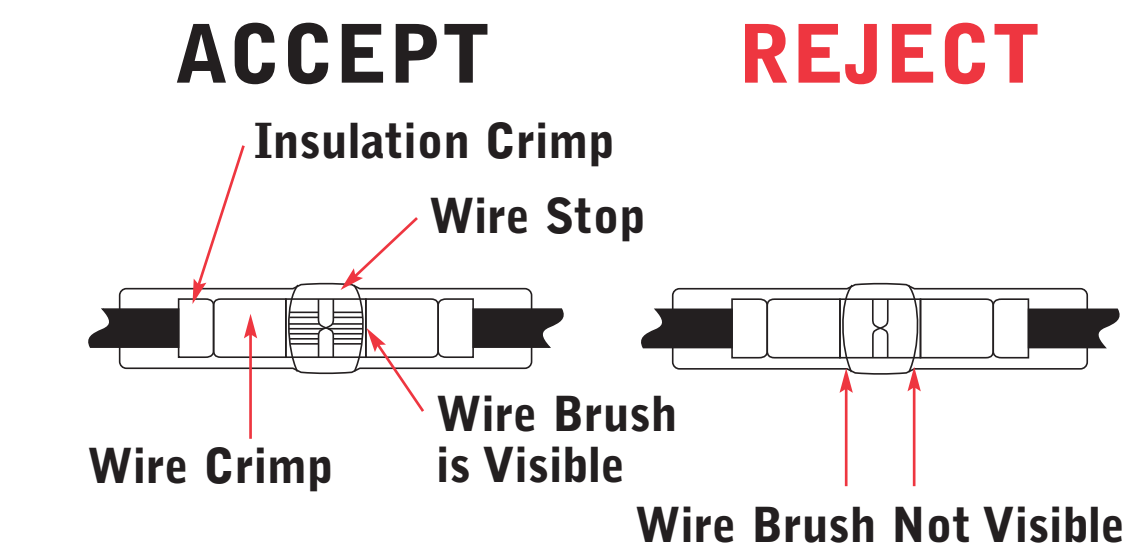

### Changing Inches to Mils

- Multiply inches by 1000 or:
- Move decimal point 3 places to right or:
- Change terminology, i.e. .032 in. = 32 thousandths or 32 mils.

### Computation of CMA

**D** = Diameter in mils  
**Round Solid Conductor:** Change diameter from inches to mils, then multiply the diameter in mils by itself.  
CMA = D mils x D mils  
**Stranded Conductor:** Find CMA of a single strand and multiply the result by the total number of strands.  
CMA = (D of one strand x D of one strand) x Number of Strands

# INSPECCIÓN VISUAL DE TERMINALES ENGARZADOS INDUSTRIAL

## Terminales de cilindro abierto

**ACEPTAR** **RECHAZAR**

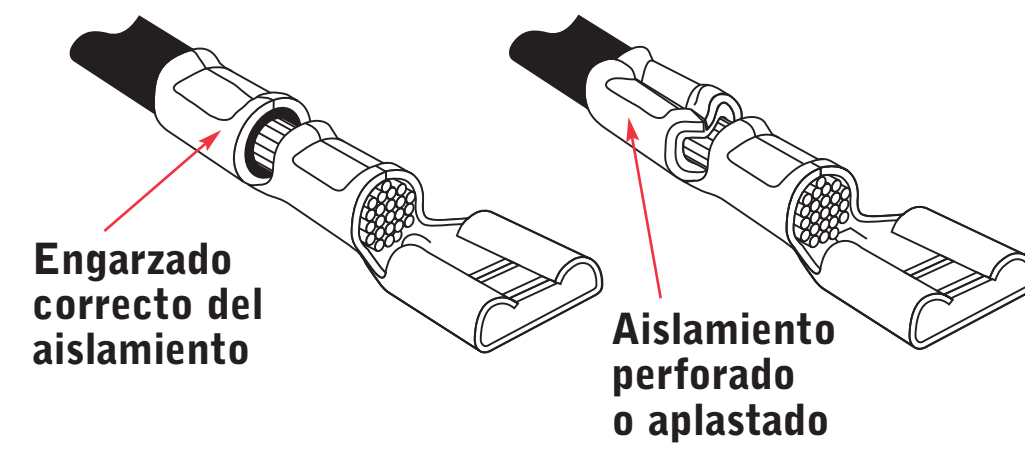

**ACEPTAR** **RECHAZAR**

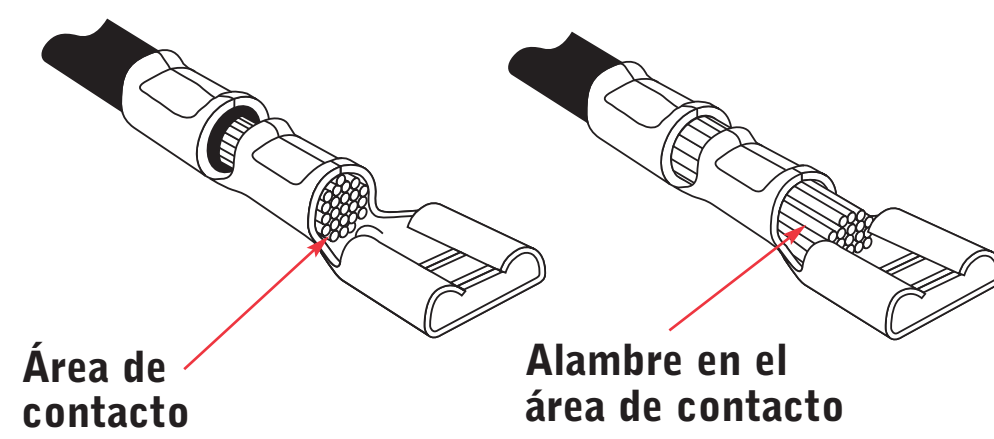

**ACEPTAR** **RECHAZAR**

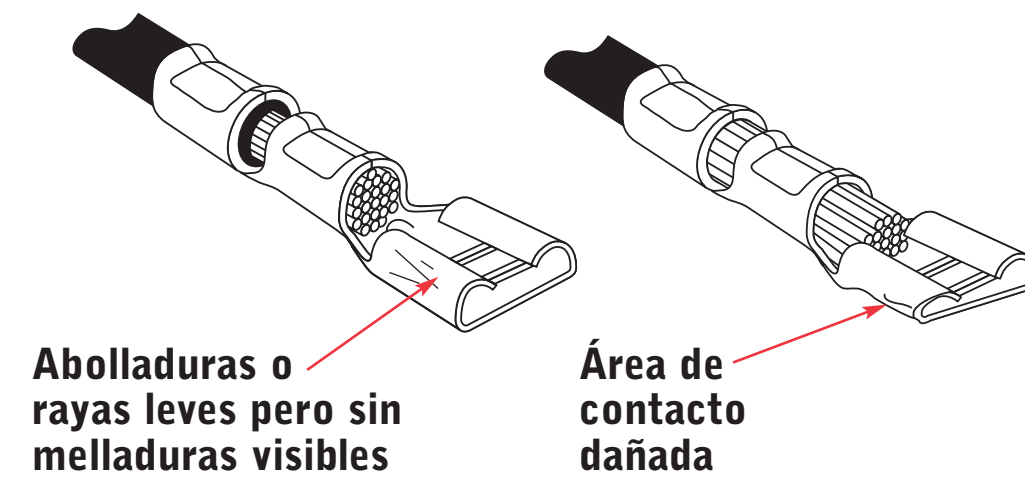

**ACEPTAR** **RECHAZAR**

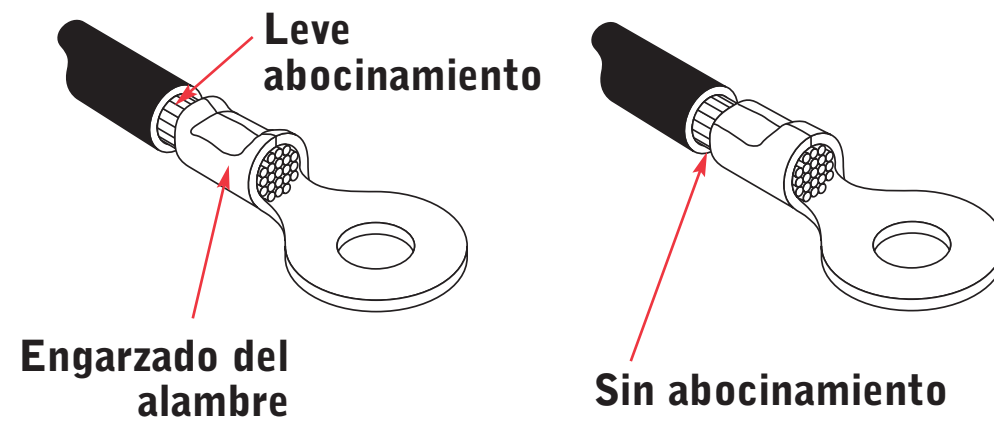

**ACEPTAR** **RECHAZAR**



**ACEPTAR** **RECHAZAR**

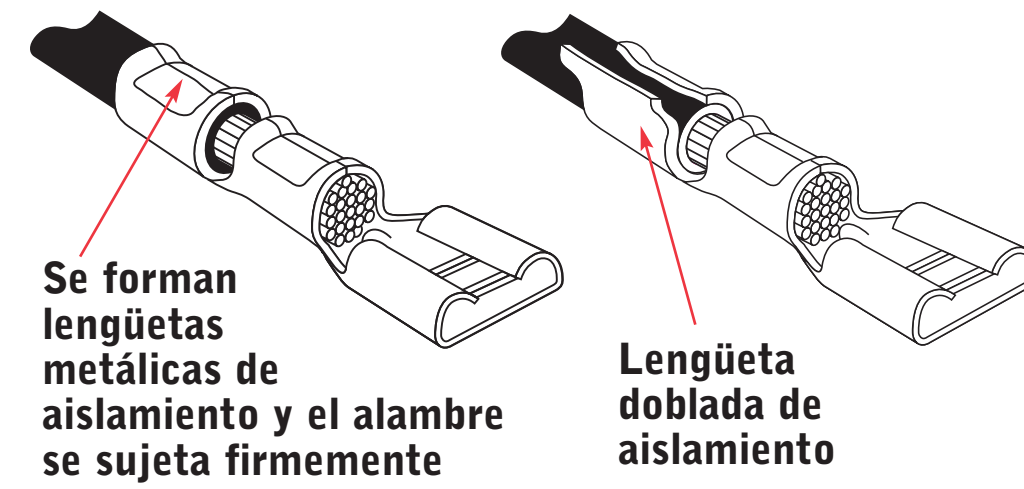

**ACEPTAR** **RECHAZAR**

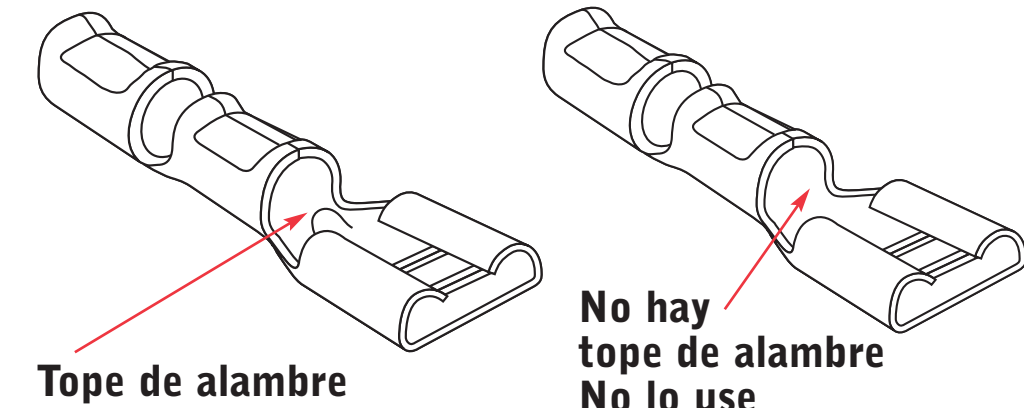

**ACEPTAR**

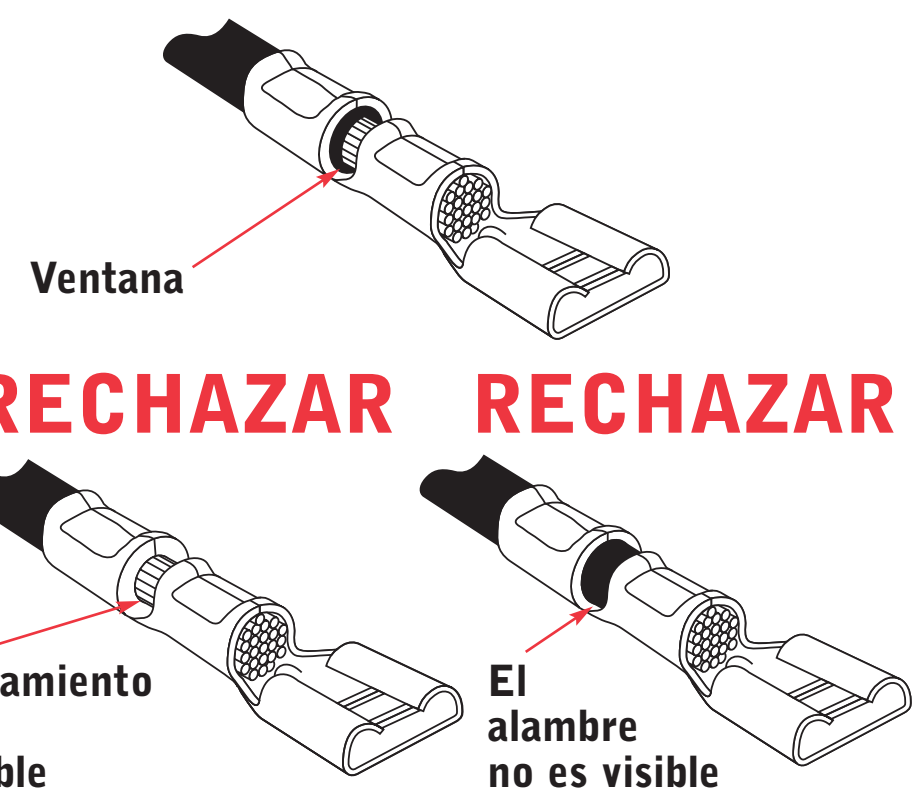

**ACEPTAR** **RECHAZAR**

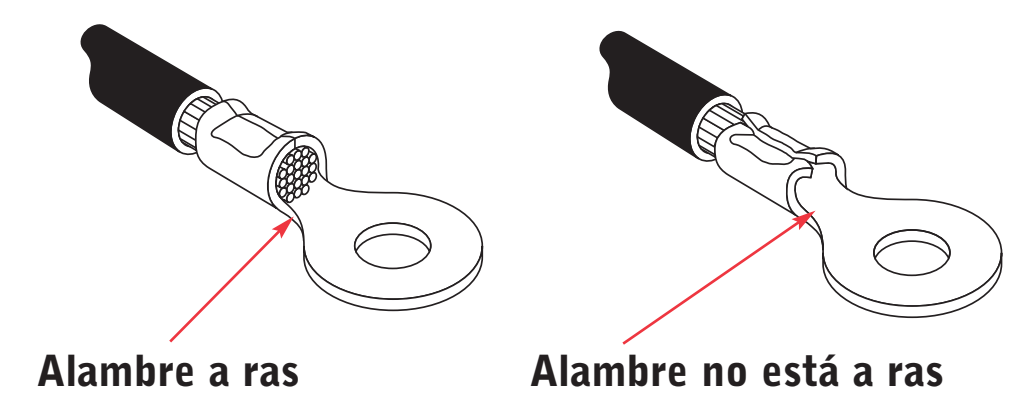

**ACEPTAR** **RECHAZAR**



## Tipos de engarzado

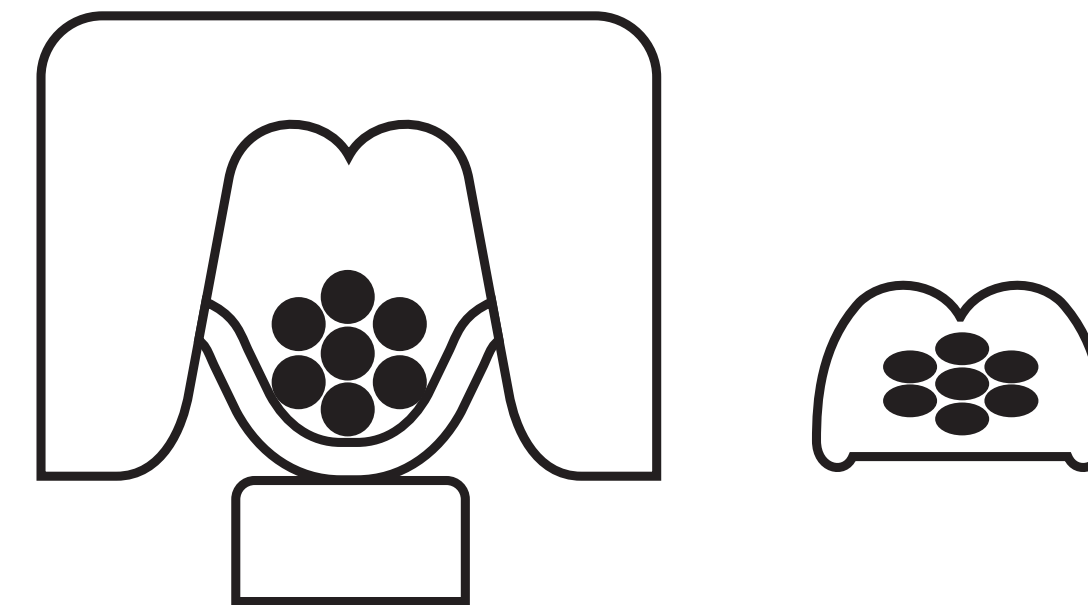

ENGARZADO F PARA TERMINALES DE CILINDRO ABIERTO

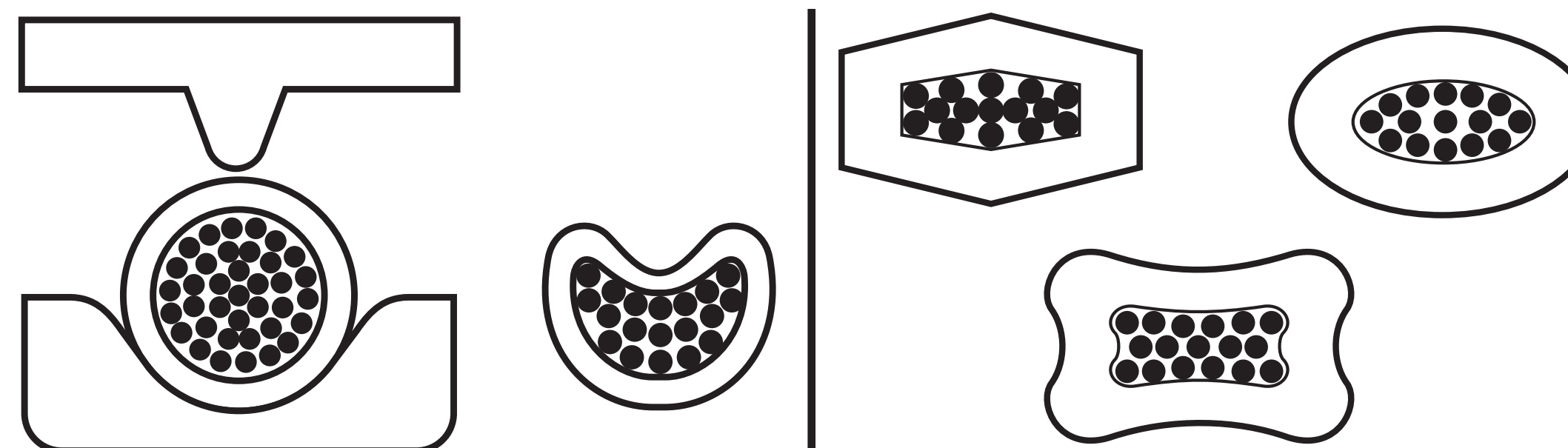

ENGARZADO HENDEDOR PARA TERMINALES DE CILINDRO CERRADO

ENGARZADO CONFINADO PARA TERMINALES DE CILINDRO CERRADO

Resistencia a la tensión en libras

Calibre del alambre	*UL-486A	*UL-486-C	*UL-310	*Uso Militar Clase 2
26	3	N/A	N/A	7
24	5	N/A	N/A	10
22	8	8	8	15
20	13	10	13	19
18	20	10	20	38
16	30	15	30	50
14	50	25	50	70
12	70	35	70	110
10	80	40	80	150
8	90	45	N/A	225
6	100	50	N/A	300
4	140	N/A	N/A	400
2	180	N/A	N/A	550
1	200	N/A	N/A	650
1/0	250	N/A	N/A	700
2/0	300	N/A	N/A	750
3/0	350	N/A	N/A	825
4/0	450	N/A	N/A	875
250 MCM	500	N/A	N/A	1000
300 MCM	550	N/A	N/A	1120
350 MCM	600	N/A	N/A	1125

\* UL - 486 A - Terminales (sólo para conductores de cobre)

\* UL - 486 C - Empalmes a tope, empalmes paralelos, conectores de extremo cerrado y conectores manuales para alambres

\* UL - 310 - Conectores rápidos, barra y acoples

\* Uso militar Clase 2 - Terminales con aprobación militar sólo de acuerdo con la lista

Tabla AWG-CMA

Tamaño de terminal	Límites CMA
26-22	202 - 810
24-20	320 - 1,020
22-18	509 - 2,600
22-16	509 - 3,260
16-14	2,050 - 5,180
14-12	3,260 - 8,213
12-10	5,180 - 13,100
8	13,100 - 20,800
6	20,800 - 33,100
4	33,100 - 52,600
2	52,600 - 83,700
1/0	83,700 - 119,500
2/0	119,500 - 150,500
3/0	150,500 - 190,000
4/0	190,000 - 231,000

Información técnica del alambre

**CMA** - Área milésima circular, es una unidad de área equivalente al área de un círculo cuyo diámetro es una milésima.

**MIL** - Una milésima equivale a 0.001 pulgadas.

0.001 = 1 mil  
0.030 = 30 mil  
0.125 = 125 mil

## Terminales de cilindro cerrado

**ACEPTAR** **RECHAZAR**

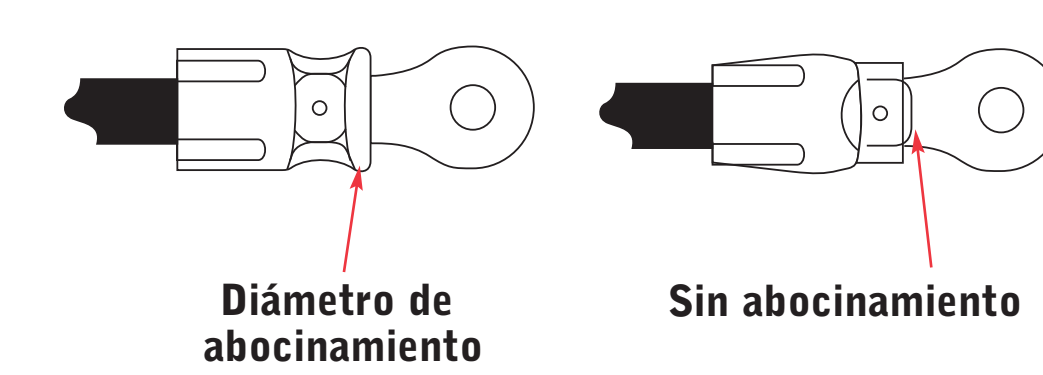

**ACEPTAR** **RECHAZAR**

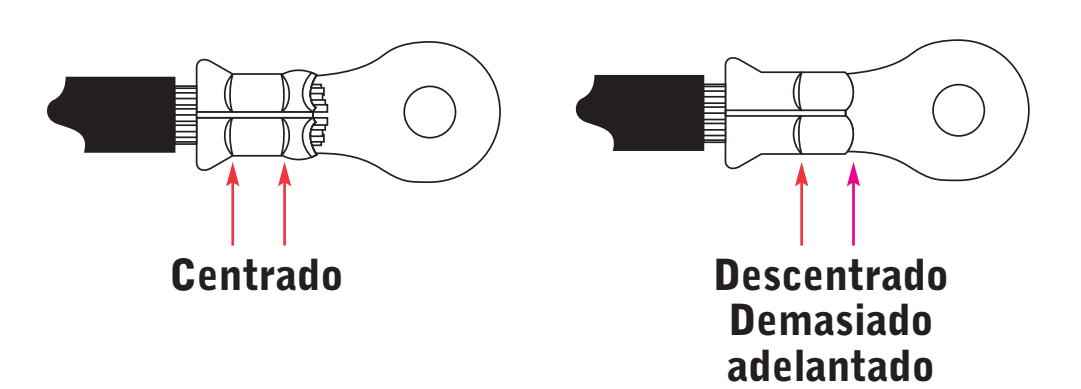

**ACEPTAR** **RECHAZAR**

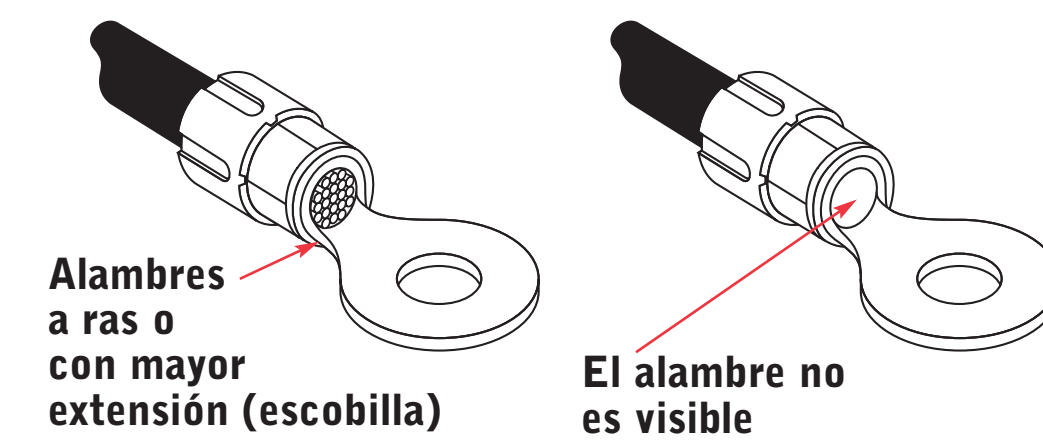

**ACEPTAR** **RECHAZAR**



**ACEPTAR**

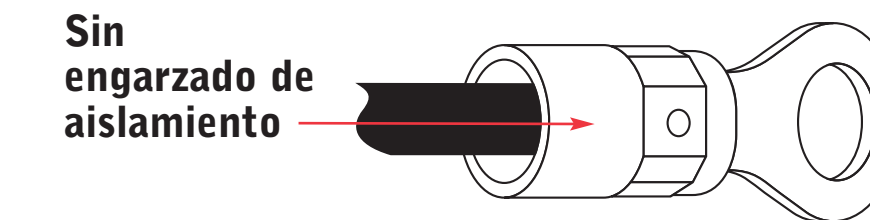

Los calibres de alambre 8 AWG y mayores no requieren el engarzado del aislamiento.

Los alambres desde 18 hasta 10 AWG requieren el engarzado del aislamiento y el alambre se puede sujetar firmemente en el engarzado del aislamiento.

ENGARZADO DE AISLAMIENTO METÁLICO

**ACEPTAR** **RECHAZAR**

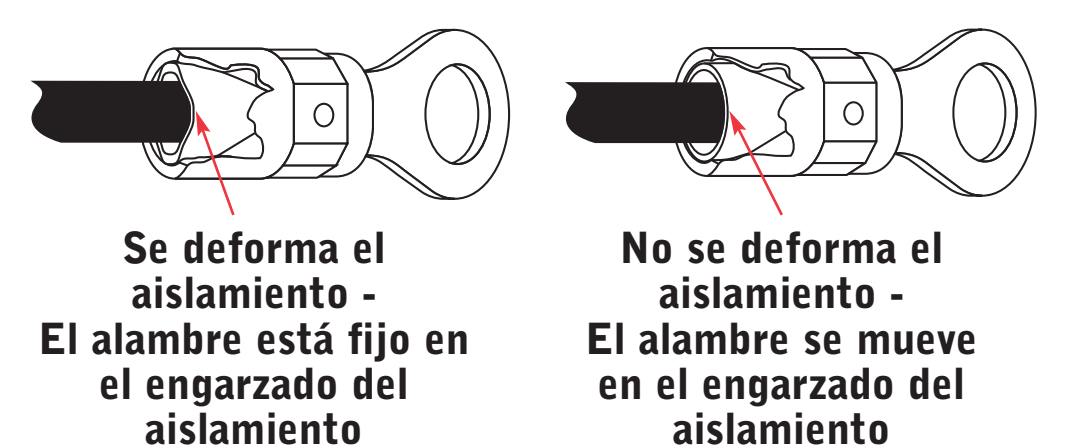

EMPALMES A TOPE

10 a 18 AWG

**ACEPTAR** **RECHAZAR**

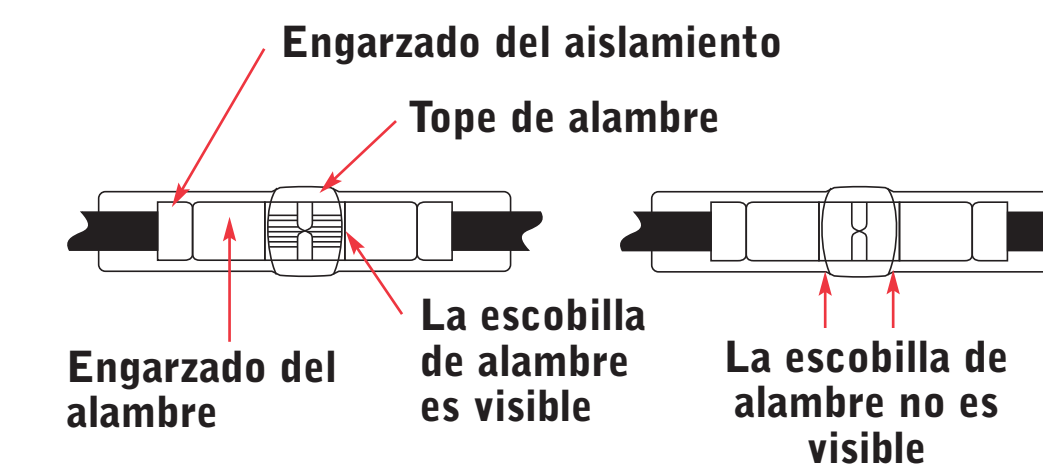

**ACEPTAR** **RECHAZAR**

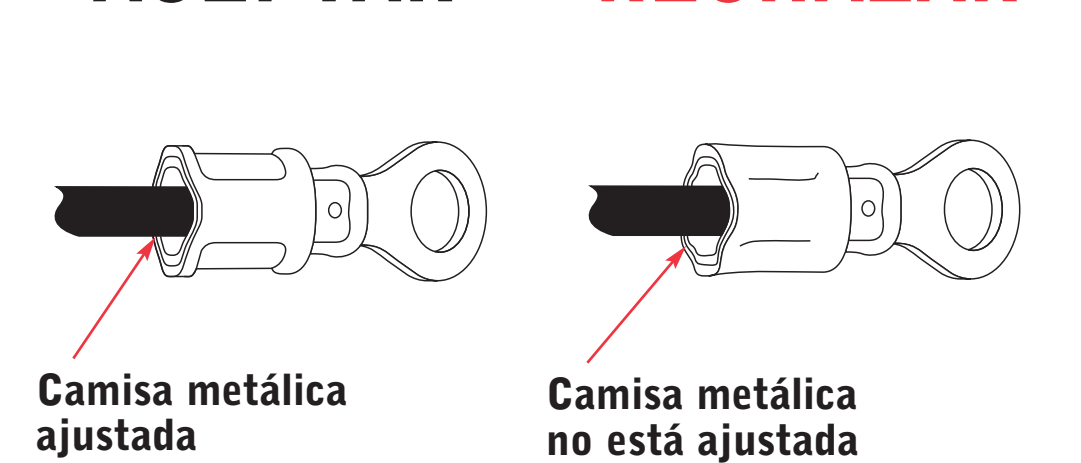

Conversión de pulgadas a milésimas

- Multiplicar las pulgadas por 1000 o:
- Mover el punto decimal 3 posiciones a la derecha o:
- Cambiar terminología, es decir 0.032 pulg. = 32 milésimas o 32 mils.

Cálculo de CMA

D = diámetro en mils

Conductor sólido circular: Cambiar el diámetro de pulgadas a milésimas, después multiplicar el diámetro en milésimas por sí mismo.  
CMA = D mils x D mils

Conductor trenzado: Determinar CMA de una sola hebra y multiplicar el resultado por el número total de hebras.  
CMA = (D de una hebra x D de una hebra) x Número de hebras